

MINDER

TWIN

0082 **UK CA 0120** **UIAA NFPA** $7 \leq \varnothing \leq 13 \text{ mm}$ **individually tested**
 EN 12278: 2007
 XF 494-2004: FZL-H-T 9.5/13

3 year guarantee / Garantie 3 ans

1. Field of application (text part)
 Champ d'application (partie texte)

2. Nomenclature

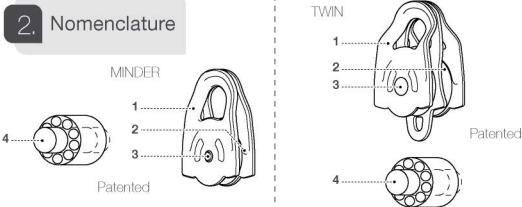

3. Inspection, points to verify
 Contrôle, points à vérifier



NFFPA CERTIFICATION FOR MINDER P60A AND TWIN P65A

MEETS THE PULLEY REQUIREMENTS OF NFFPA 1983, INCORPORATED IN THE 2022 EDITION OF NFFPA 2500.

CONFORMES AUX EXIGENCES POULIES DE LA NORME NFFPA 1983, DE L'ÉDITION 2022 DE LA NORME NFFPA 2500.



**PULLEY: MBS 36 kN
 G (GENERAL USE)
 MEETS NFFPA 2500
 (1983) - 2022**

After removing the notice from the equipment, make a copy of it and keep the original as part of a permanent record that includes the usage and inspection history for the equipment. Keep the copy of the notice with the equipment and refer to it before and after each use. Additional information regarding auxiliary equipment can be found in NFFPA 1500 and NFFPA 1858 and NFFPA 1983, incorporated in the 2022 edition of NFFPA 2500.

Après avoir détaché la notice du produit, faites en une copie et gardez l'original dans un dossier qui compile l'historique de vie du produit et les vérifications EPI réalisées. Gardez une copie de la notice avec le produit et consultez-la avant et après chaque utilisation. Des informations complémentaires sont disponibles dans la NFFPA 1500, NFFPA 1858 et NFFPA 1983, incorporées dans l'édition 2022 de la norme NFFPA 2500.



This product is compliant with the Regulation 2016/425 on Personal Protective Equipment as brought into UK law and amended. Ce produit est conforme au règlement 2016/425 sur les équipements de protection individuelle tel que transposé en droit britannique et modifié.

Approved Body performing the UKCA type examination:
 Organisme approuvé intervenant pour l'examen UKCA de type :

SATRA Technology Centre Limited
Wyndham Way, Telford Way,
Kettering, Northamptonshire,
NN16 8SD, United Kingdom.
N° 0321

Approved body responsible for the production control of this PPE:
 Organisme approuvé responsable du contrôle de production de cet EPI :

SGS United Kingdom Ltd
Inward Way
Rossmore Business Park
Ellesmere Port, Cheshire, CH65 3EN
United Kingdom
N° 0120

Authorized Representative in UK : PETZL UK Agency, Unit 3-7, Tebay Business Park, Old Tebay, Penrith, CA10 3SS, United Kingdom

4. Compatibility Compatibilité

MINDER / TWIN

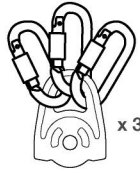

TWIN

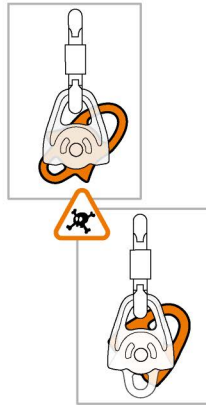

5. Strength Résistance

5A. Working load limit / Valeur d'utilisation maxi

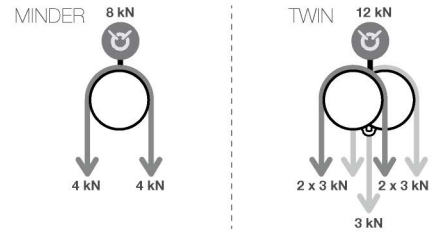

5B. Breaking load / Charge de rupture

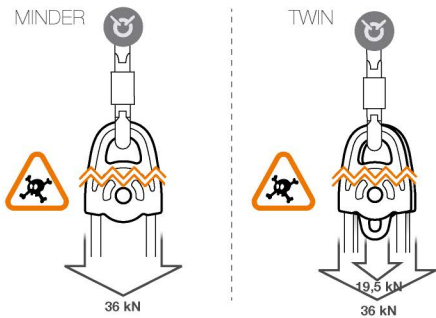

Traceability and markings Traçabilité et marquage

MINDER

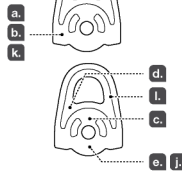

TWIN

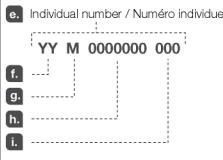
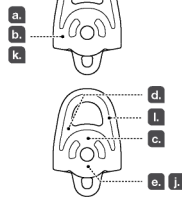

7. Progress capture systems Systèmes anti-retour

MINDER / TWIN

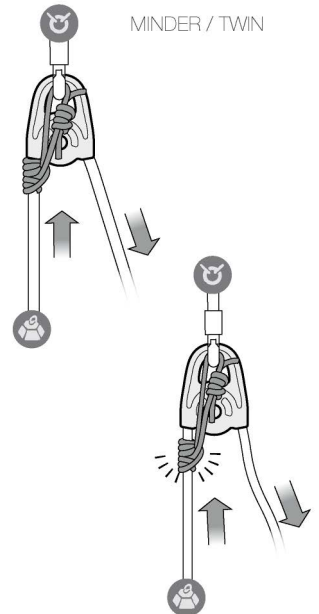

6. Efficiency Rendement

with progress capture

6B. 2:1 hauling system

6A. Simple pulley system

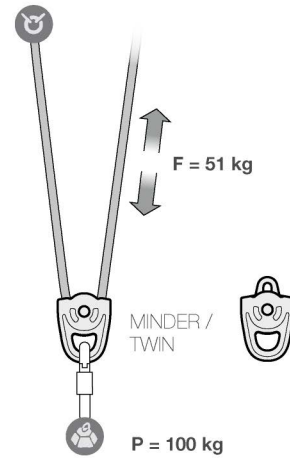
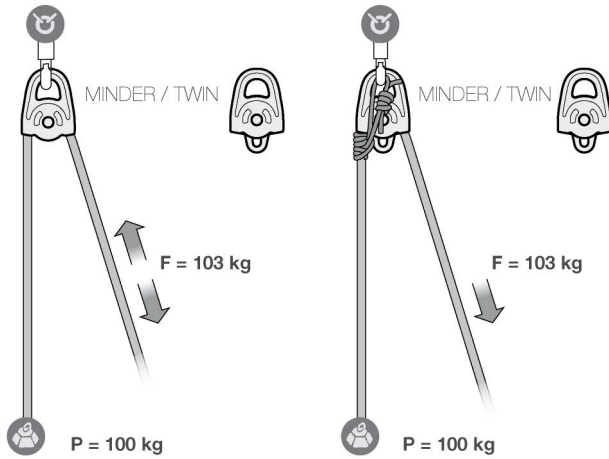

Theoretical force



	$F = P$	$F = 0,5 P$
	$F = 1,03 P$	$F = 0,51 P$
	$F = 2 P$	$F = 0,66 P$

6C. 3:1 hauling system

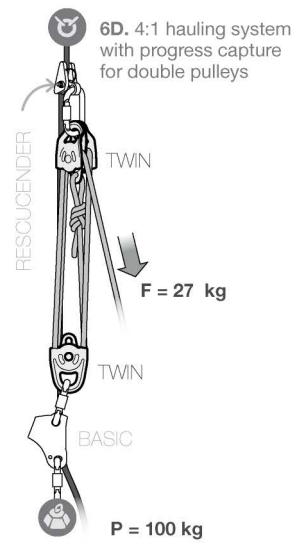
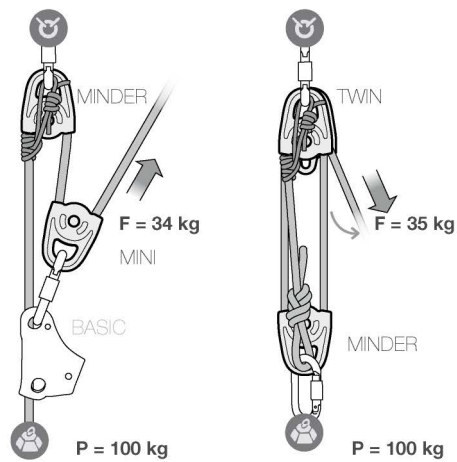

Theoretical force

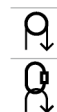

	$F = 0,33 P$	$F = 0,25 P$
	$F = 0,34 P$	$F = 0,27 P$
	$F = 0,57 P$	$F = 0,937 P$

7. Progress capture systems
Systèmes anti-retour

MINDER / TWIN

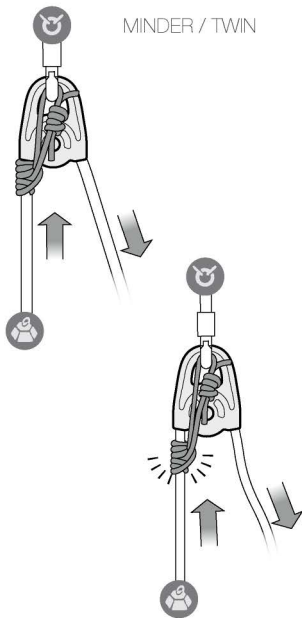

8. Positioning and redirection
Positionnement et renvoi

