



1. Field of application (text part)
Champ d'application (partie texte)

GRILLON

CE 0082 EAC TPTC019/2011 UK CA 0120

WARNING / ATTENTION

Activities involving the use of this equipment are inherently dangerous. You are responsible for your own actions and decisions.

- Before using this equipment, you must:
- Read and understand all Instructions for Use.
 - Get specific training in its proper use.
 - Become acquainted with its capabilities and limitations.
 - Understand and accept the risks involved.

FAILURE TO HEED ANY OF THESE WARNINGS MAY RESULT IN SEVERE INJURY OR DEATH.

Les activités impliquant l'utilisation de cet équipement sont par nature dangereuses. Vous êtes responsable de vos actes, de vos décisions et de votre sécurité.

- Avant d'utiliser cet équipement, vous devez :
- Lire et comprendre toutes les instructions d'utilisation.
 - Vous former spécifiquement à l'utilisation de cet équipement.
 - Vous familiariser avec votre équipement, apprendre à connaître ses performances et ses limites.
 - Comprendre et accepter les risques induits.

LE NON-RESPECT D'UN SEUL DE CES AVERTISSEMENTS PEUT ÊTRE LA CAUSE DE BLESSURES GRAVES OU MORTELLES.

PETZL.COM



Latest version
Dernière version



Other languages
Autres langues



Technical tips
Conseils techniques



PPE checking
Fiche de contrôle EPI

Warning symbols
Panneaux d'alertes



PETZL
FR-38920 Crolles
PETZL.COM
Tel: +33 (0)4 76 92 09 00
ISO 9001
© Petzl



Sustaining our Community
Au service de la Communauté
FONDATION-PETZL.ORG

2. Nomenclature

12

11

1

2

7

8

4

9

10

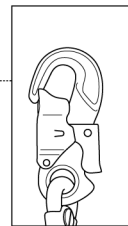

HOOK
European
version

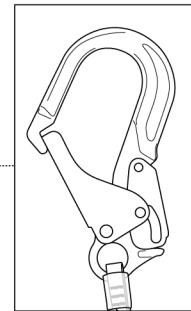

MGO 60 INT
International
version

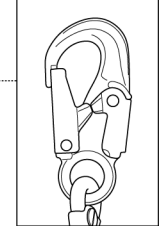

HOOK
International
version

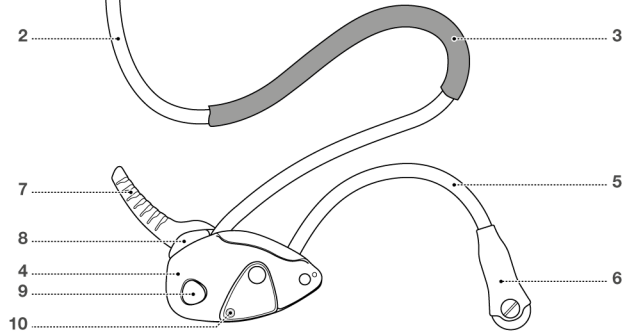

Traceability and markings / Traçabilité et marquage

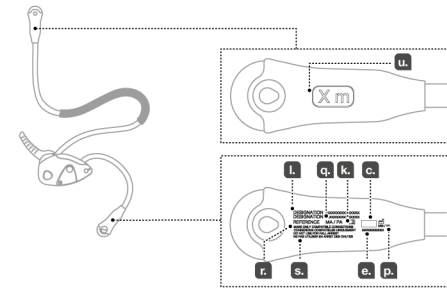
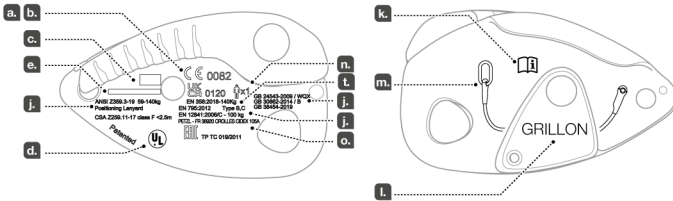

CE 0082

a. ARAVE EXPLOITATION
FRANCE SAS
6 Rue du Général Audran
92412 Courbevoie cedex - France
N°0182

b. Dolomiticert Scarl
Z.I. Villanova -
32013 Longarone (BI)
N°2006



d. POSITIONING LANYARD
IN ACCORDANCE WITH
ANSI/ASSP Z359.3-19
LANYARD, CLASS F,
IN ACCORDANCE WITH
CSA Z259.11-17

e. Individual number / Numéro individuel

YY M 0000000 000

f.

g.

h.

i.

3. Inspection, points to verify
Contrôle, points à vérifier

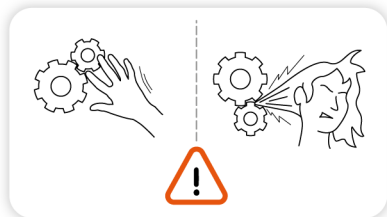
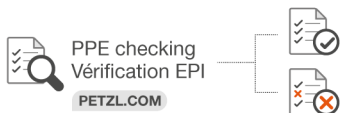

4. Compatibility
Compatibilité



Frequent connections
Connexions fréquentes

Examples / exemples



Sm'D
WILLIAM

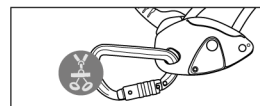

or / ou

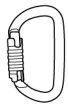

Am'D
OK
OXAN



CAPTIV

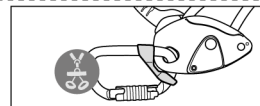

or / ou



Am'D
OK
OXAN



MICRO
SWIVEL

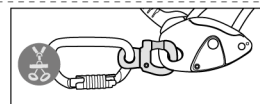

Semi-permanent connection
Connexion semi-permanente



SWIVEL
OPEN

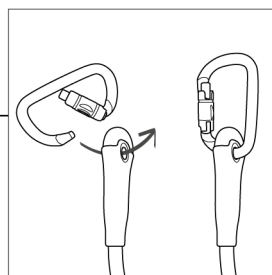
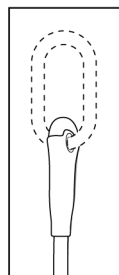

or / ou

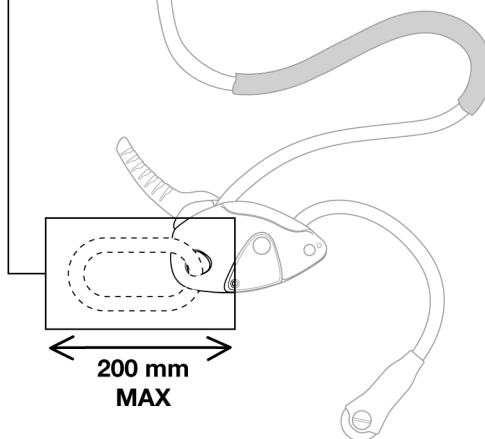
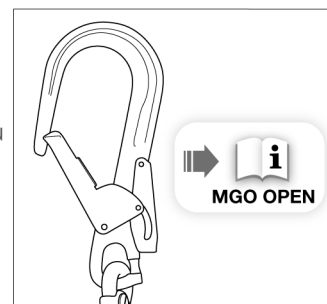

Standards / Normes

EN 358 EN 12841 EN 795

ANSI Z359.3 CSA Z259.11

GB 24543 GB 30862 GB 38454

Connector
Connecteur
EN 362

Connector
Connecteur
ANSI CSA

Connector
Connecteur
GB 23469



5. Working principle
Principe fonctionnement

Tensioning the rope
or shortening
the lanyard /
Tendre la corde
ou raccourcir la longe

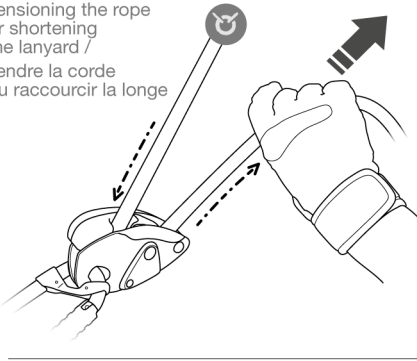

Locking / Blocage

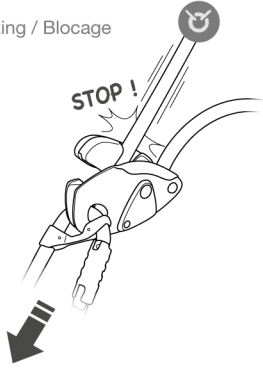

Lengthening the lanyard in double mode /
Agrandir la longe en usage à double

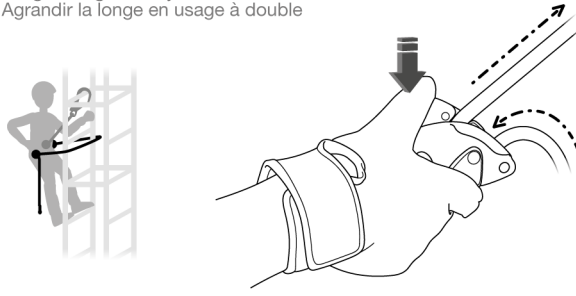

Lengthening the lanyard in single mode or releasing under load /
Agrandir la longe en usage à simple ou débloquer sous charge

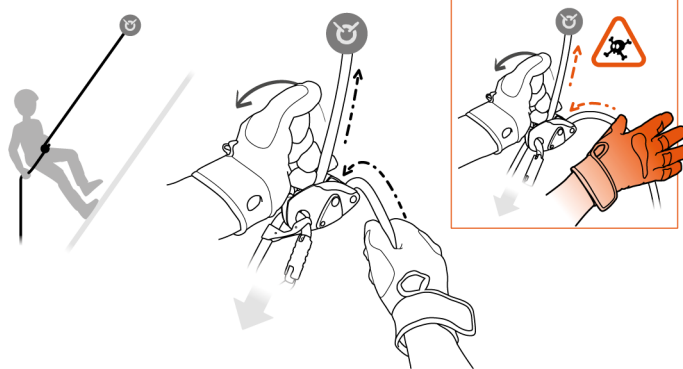

6. Adjustable lanyard for work positioning
Longe réglable de maintien au travail

EN 358:2018

ANSI Z359.3-2019

CSA Z259.11-17 F (<2,5m)

GB 24543-2009 / WQX

6a. Double mode use / Utilisation en double

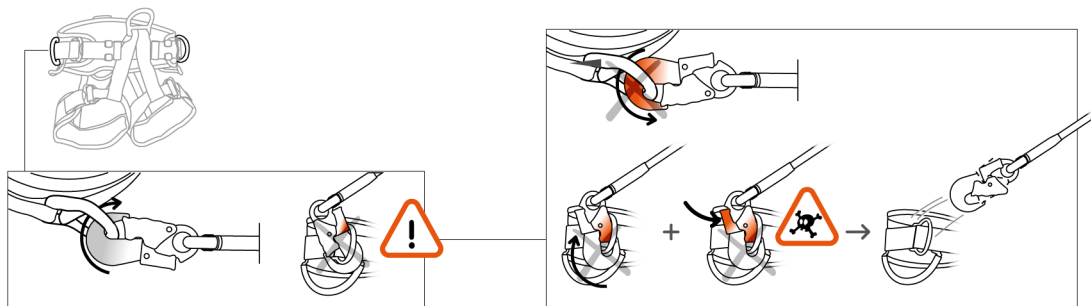
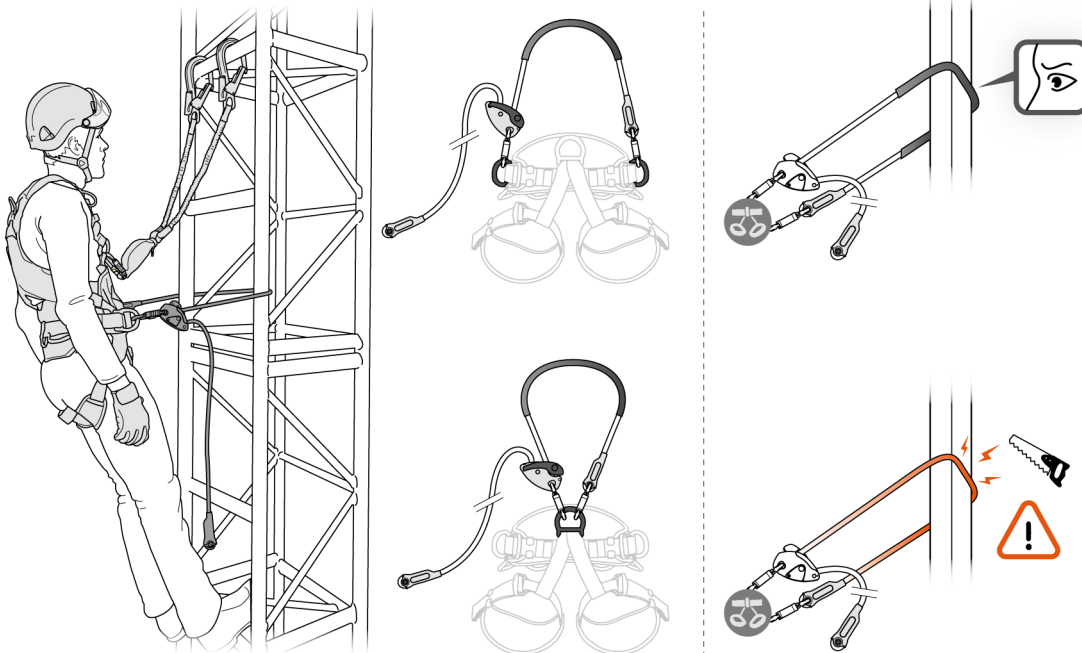

6b. Single mode use /
Utilisation à simple

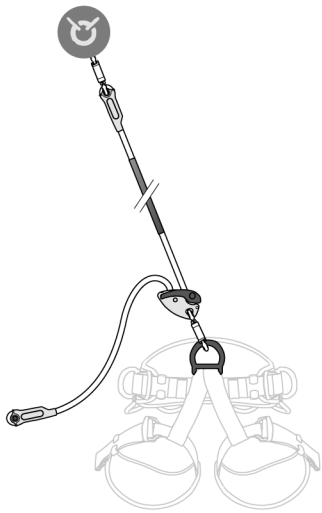

6c. Precautions / Précautions

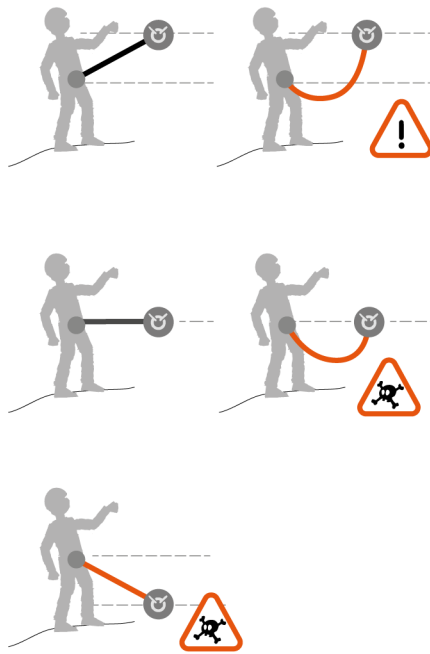

7. Descender
Descendeur **EN 12841: 2006 type C**

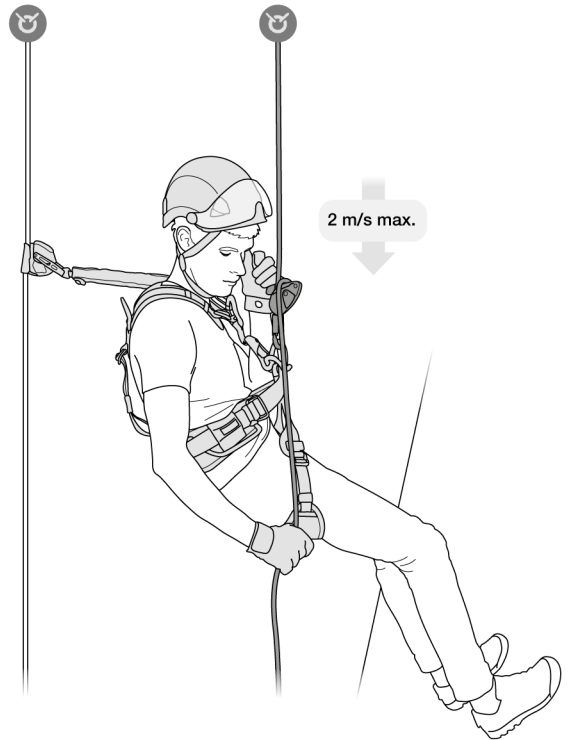

8. Temporary anchor for wrapping around a structure
Ancrage provisoire pour ceinturer une structure

EN 795 : 2012 type B

GB 30862-2014 / B

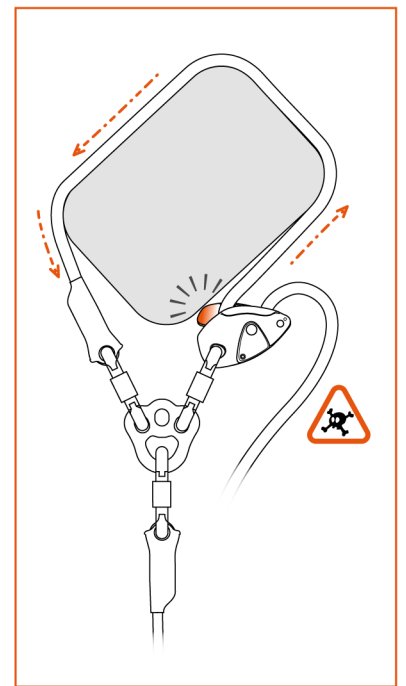
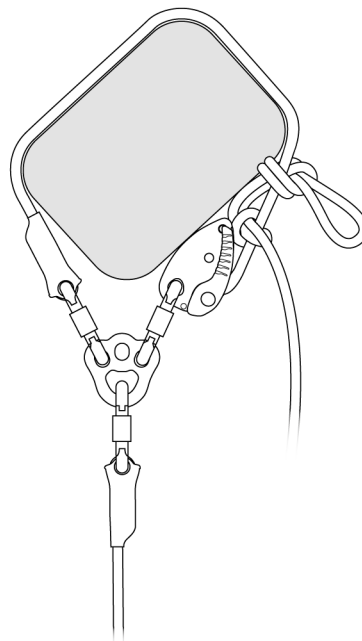
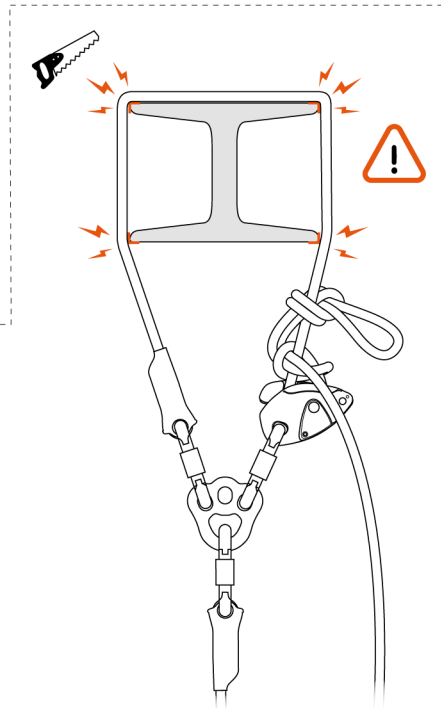
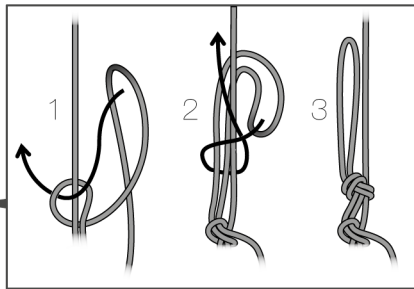
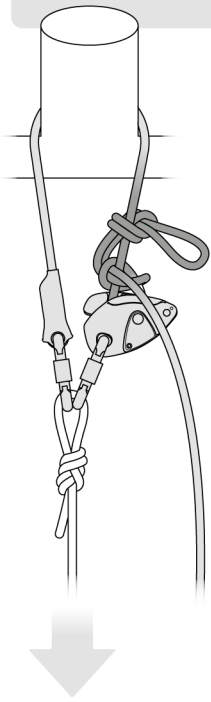

Initial tension / Tension initiale :

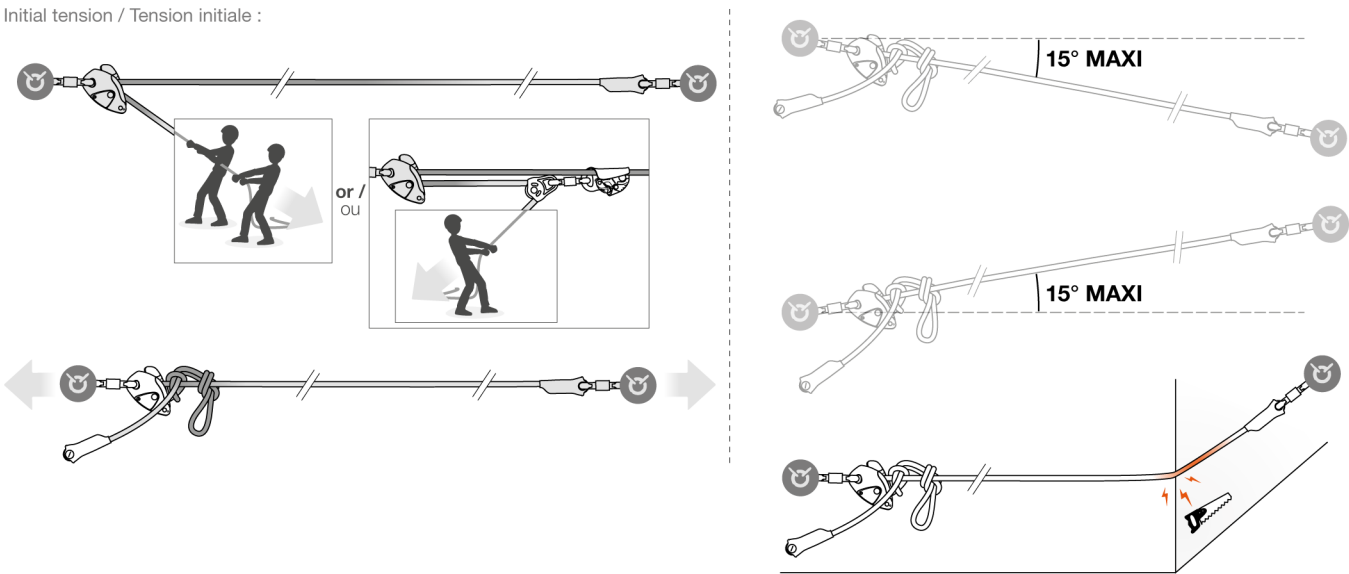

Attachment to the lifeline / Connexion à la ligne de vie :

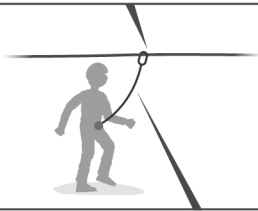
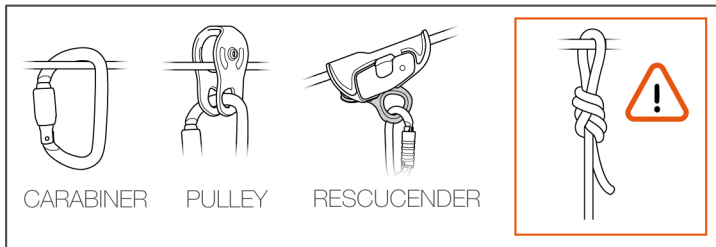

Example / exemple :

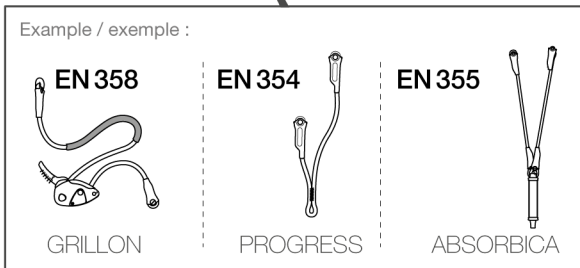

Information on sag and clearance / Information sur la flèche et le tirant d'air

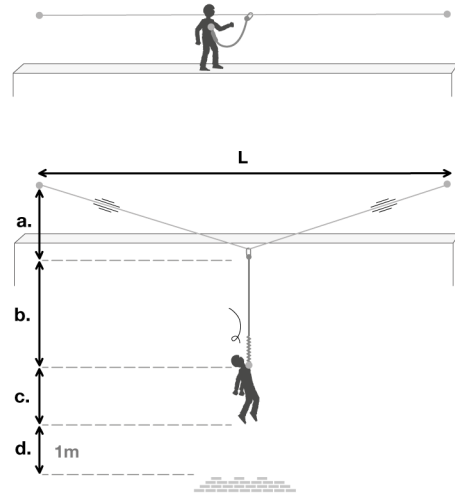

L	1m	2m	3m	5m	10m	15m	20m
a.	0,37m	0,5m	0,6m	1m	1,9m	2,8m	3,7m

9 kN

10. Spare parts
Pièces détachées

L052FAXX



L052JAXX



L052GAXX

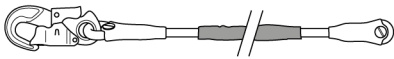

L052HAXX

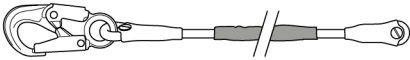

L052IAXX

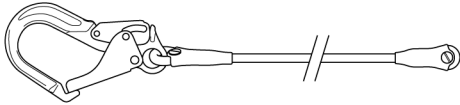

Installation of the rope /
Installation de la corde

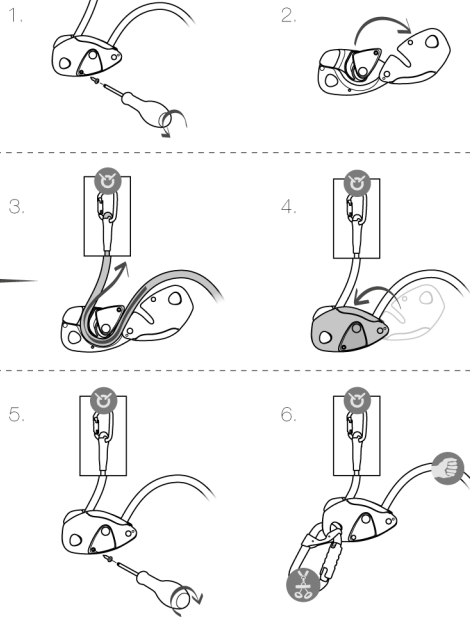
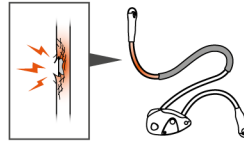

11. Additional information
Informations complémentaires



A. Lifetime / Durée de vie



unlimited
illimitée

C. Acceptable T°
T° tolérées



+ 80°C / + 176°F
- 30°C / - 22°F

D. Precautions for use / Précautions d'usage



E. Cleaning / Nettoyage



+ 30°C maxi.
+ 86°F maxi.

F. Drying / Séchage



+ 30°C maxi.
+ 86°F maxi.

G. Storage - Transport
Stockage - transport



H. Maintenance
Entretien



I. Modifications - Repairs
Modifications - Réparations

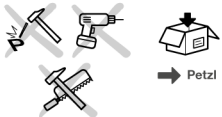

→ Petzl

J. FAQ - Contact
Questions - Contact



→ petzl.com



A. Lifetime /
Durée de vie



Serial n°
XXXX XX XXXX + 10
years
ans

B. Markings
Marquage



C. Acceptable T°
T° tolérées



+ 80°C / + 176°F
- 40°C / - 40°F

D. Precautions for use / Précautions d'usage



E. Cleaning - Disinfection / Nettoyage - Désinfection



+ 30°C maxi.
+ 86°F maxi.

F. Drying / Séchage

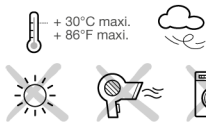

+ 30°C maxi.
+ 86°F maxi.

G. Storage - Transport
Stockage - transport



J. FAQ - Contact /
Questions - Contact



→ petzl.com

EN

These instructions explain how to correctly use your equipment. Only certain techniques and uses are described.
The warning symbols inform you of some potential dangers related to the use of your equipment, but it is impossible to describe them all. Check Petzl.com for updates and additional information. You are responsible for heeding each warning and using your equipment correctly. Any misuse of this equipment will create additional dangers. Contact Petzl if you have any doubts or difficulty understanding these instructions.

1. Field of application

Personal protective equipment (PPE) used for fall protection from height.
Adjustable lanyard for work positioning.
Descender:
Temporary anchor.
Horizontal lifeline.
GRILLON.
GRILLON PLUS (highly abrasion-resistant rope).
GRILLON HOOK European version (with pre-installed connector).
GRILLON HOOK international version (with pre-installed connector).
GRILLON MGO (with pre-installed connector).

For single-person use only.
Helps prevent falls when used as adjustable lanyard for work positioning and descender.
Protects against falls from height when used as temporary anchor.
Do not use this equipment as a means of hoisting.
This product must not be pushed beyond its limits, nor be used for any purpose other than that for which it is designed.

Responsibility

WARNING
Activities involving the use of this equipment are inherently dangerous.
You are responsible for your own actions, decisions and safety.

Before using this equipment, you must:
- Read and understand all Instructions for Use.
- Get specific training in its proper use.
- Become acquainted with its capabilities and limitations.
- Understand and accept the risks involved.

Failure to heed any of these warnings may result in severe injury or death.

This product must only be used by competent and responsible persons, or those placed under the direct and visual control of a competent and responsible person.
You are responsible for your actions, your decisions and your safety and you assume the consequences of same. If you are not able, or not in a position to assume this responsibility, or if you do not fully understand the Instructions for Use, do not use this equipment.

2. Nomenclature

(1) Rope termination with plastic sleeve and attachment hole, (2) Rope in use - lanyard, (3) Protective sheath (only on GRILLON, GRILLON HOOK European version and GRILLON HOOK international version less than 5 m in length), (4) Rope adjuster, (5) Reserve rope (free rope), (6) Sewn termination with screw-in plug, (7) Handle, (8) Cam, (9) Attachment hole, (10) Side plate locking screw, (11) Lanyard-end connector to be installed, (12) Pre-installed connector (depending on model).
Principal materials: aluminum, stainless steel, nylon, polyester, aramid.

3. Inspection, points to verify

Your safety depends upon the integrity of your equipment.
Petzl recommends a detailed inspection by a competent person at least once every 12 months (depending on current regulations in your country, and your conditions of usage). **WARNING:** your intensity of use may cause you to inspect your PPE more frequently. Follow the procedures described at Petzl.com. Record the results on your PPE inspection form: type, model, manufacturer contact info, serial number or individual number, dates: manufacture, purchase, first use, next periodic inspection; problems, comments, inspector's name and signature.
For use as an anchor device, affix a marking indicating the date of the next (or last) inspection.

Before each use

On the rope adjuster, verify the absence of deformation, cracks, marks, wear, corrosion... Check the movement of the handle, and that its return spring is working. Check that the cam moves freely.
Check the rope and the safety stitching: look for cuts, cut or loose threads, wear and damage due to use, to heat, to chemicals.
Verify the absence of foreign objects in the mechanism.

During use

It is important to regularly monitor the condition of the product and its connections to the other equipment in the system. Make sure that all items of equipment are correctly positioned with respect to each other.
Beware of any pressure on the cam that can cause unlocking.
Each time the connector is used, verify that it is properly closed and locked.
Warning: the GRILLON PLUS rope with aramid sheath is highly abrasion-resistant, but is not particularly heat-resistant; observe the specified operating temperatures.

4. Compatibility

Verify that this product is compatible with the other elements of the system in your application (compatible = good functional interaction).
When using multiple items of equipment, a dangerous situation can arise in which the safety function of an item of equipment can be affected by the safety function of another item of equipment.
Equipment used with your GRILLON must meet current standards in your country (e.g. EN 362 carabiners).

Lanyard-end connector:

Use the plastic sheath for better connector positioning.

Rope adjuster connector:

Frequent connections: if you must frequently detach your device from the harness, use a locking carabiner with a positioning system, like the CAPTIV bar or the MICRO SWIVEL.
Semi-permanent connector: when possible, use a semi-permanent connector that locks with a tool.
If using any other connector, carry out a compatibility test (correct installation and functioning, and check for any possibility of poor positioning).
WARNING: connectors used without a CAPTIV or other positioning system can rotate and block the cam.

Spare parts

Replace your lanyard only with Petzl GRILLON ropes.

5. Working Principle

Tensioning the rope or shortening the lanyard: pull on the free rope.
Blocking: make sure the cam can pivot freely to block the rope.
Lengthening the lanyard in double mode: if the rope is lightly loaded, push on the cam to feed slack.
Lengthening the lanyard in single mode or releasing under load: the handle enables the taut rope to be loosened. Control the rate of release by holding the brake side of the rope.

WARNING: there is a fall risk if the cam or handle are manipulated without holding the free rope.

Braking and speed control are achieved by varying your grip on the free rope.

6. Adjustable lanyard for work positioning

EN 358-2018
GB 245435-2009/WQX

Working load: 140 kg.
Keep your lanyard taut; stay below the anchor.

ANSI Z359.3 for 130-310 lbs, or 59-140 kg.
CSA Z259.11-17 class F (up to 2.5 m).

6a. Double mode use

Pass the lanyard around a suitable anchor (sufficient strength, sufficient diameter, absence of sharp or abrasive edges...).
Attach the lanyard termination to the harness, preferably to the side attachment point opposite the one holding the rope adjuster. Pay attention to the orientation of the HOOK's attachment to the harness: there is a risk of unhooking in the event of rubbing.

6b. Single mode use

Attach the lanyard termination to an anchor.

6c. Precautions

Adjust the lanyard length to keep your weight on the system, while staying below the anchor.
The GRILLON lanyard must not be used for fall arrest. It may be necessary to supplement the work positioning system with a fall-arrest system.
Do not use a work positioning belt if there is a foreseeable risk of the user becoming unintentionally suspended or exposed to uncontrolled tension by the waistbelt.
Beware when using the GRILLON near moving machinery or electrical hazards.

7. Descender

EN 12841: 2006 type C

Working load: 100 kg.
Use the GRILLON for progression on the work rope, together with a type A backup device on a safety rope.
Ropes tested during the CE EN 12841 type C certification: Petzl GRILLON and GRILLON PLUS.
Use the GRILLON only with Petzl GRILLON or GRILLON PLUS ropes; Petzl GRILLON and GRILLON PLUS ropes meet the requirements of the EN 1891 standard.
To reduce the risk of a fall or pendulum, keep the rope between the GRILLON and the anchor as tight and as vertical as possible.
For instructions on installing the rope adjuster on the rope, see the Spare Parts section.
When your body weight is on the work rope, make sure that the safety rope is not loaded. When the full weight of the user is on the safety rope, it becomes a work rope and so must be used with another safety rope.

A dynamic overload can damage the safety rope.
The GRILLON is not suitable for use in a fall-arrest system.

8. Temporary anchor for wrapping around a structure

EN 795: 2012 type B
GB 30862-2014/B

Pass the lanyard around a suitable anchor (sufficient strength, sufficient diameter, absence of sharp or abrasive edges...). The strength of the anchor is no greater than the strength of the wrapped structure.
To secure your anchor, make a mule knot - tied off with an overhand knot close to the rope adjuster - on the free end of a fall.
Adjust the rope length to prevent any uncontrolled movement during use.
Maximum anchor strength and maximum load transmissible to the structure: 18 kN.

9. Horizontal lifeline

EN 795: 2012 type C
GB 38454-2019
Initial tension

The initial tension in the lifeline (about 1 kN) can be achieved by having two persons pull on the free rope, or by one person using a 3:1 haul system (see diagrams).
Warning: excessive initial tension may allow for a slight reduction in clearance in the event of a fall on the lifeline, but it increases the load on the anchors.
Maximum lifeline strength and maximum load transmissible to the structure: 18 kN.

Attachment to the lifeline

The lifeline is for single-person use only.
Attach yourself to the lifeline with an EN 354 or EN 358 lanyard, or a lanyard with an EN 355 energy absorber. Follow the lanyard's Instructions for Use, especially regarding the position relative to the anchor, and permissible fall height.
The lifeline may not be used with a retractable type fall arrester.

Information on deflection and clearance

When installing the lifeline, provide enough clearance to prevent the user from hitting the ground or an obstacle in the free event of a fall. Verify that the deflection, with the lifeline loaded or in the event of a fall, does not cause the lifeline to come into contact with an edge or any other obstacle that could damage the rope.
Clearance includes the sag in the lifeline when loaded (a), the maximum lanyard length after a fall (including possible energy absorber deployment) (b), average user height (c), and a safety margin of 1 meter (d).
The deflection values given here were measured during certification testing, with a 9 kN dynamic load. A fall during use may be less severe. During these tests, the energy transmitted to the anchors was less than 6 kJ.
WARNING: the required clearance can increase significantly if a lifeline and a fall-arrest system are used together, but have not been tested in combination.

10. Spare parts

Replace your worn rope only with Petzl GRILLON ropes.

Installing the rope:

To remove the rope, remove the screw and open the rope adjuster.
To install the rope, remove the side plate locking screw with a screwdriver, open the rope adjuster and insert the rope. Ensure the rope is installed in the device in the proper direction (see diagrams). Be sure to close the rope adjuster and replace the locking screw before each use.

11. Additional information

This product meets the requirements of Regulation (EU) 2016/425 on personal protective equipment. The EU declaration of conformity is available at Petzl.com.
- When the anchor device is used as part of a fall-arrest system, the user must be equipped with a means of limiting the impact force, exerted on the user when the fall is arrested, to a maximum value of 6 kN.
- The maximum load that can be transmitted to the structure by the anchor is approximately 18 kN.
- You must have a rescue plan and the means to rapidly implement it in case of difficulties encountered while using this equipment.
- The anchor point for the system should preferably be located above the user's position and meet EN 354 or ANSI Z359.2 requirements.
- In a fall-arrest system, it is essential to check the required clearance below the user before each use, in order to avoid hitting the ground or an obstacle in the event of a fall.
- Make sure that the anchor point is correctly positioned, in order to reduce the pendulum risk and the fall distance.
- A fall-arrest harness is the only device allowable for supporting the body in a fall-arrest system.
- When using multiple items of equipment, a dangerous situation can arise in which the safety function of an item of equipment can be affected by the safety function of another item of equipment.
- **WARNING - DANGER:** ensure that your products do not rub against abrasive materials, or sharp edges/objects.
- Users must be medically fit for activities at height. **WARNING:** inert suspension in a harness can result in serious injury or death.
- The Instructions for Use for each item of equipment used in conjunction with this product must be followed.
- The instructions for Use must be provided to the user of this equipment, in the language of the country where the equipment is used.
- Keep the Instructions for Use in a permanent file for reference after removing them from the equipment.
- Make sure the product markings are present and legible.

When to retire your equipment:

WARNING: an exceptional event can lead you to retire a product after only one use, depending on the type and intensity of usage and the environment of usage (harsh environments, marine environments, sharp edges, extreme temperatures, chemicals...).
A product must be retired when:
- It has exceeded its lifespan.
- It has been subjected to a major fall or load.
- It fails to pass inspection. You have any doubt as to its reliability.
- You do not know its full usage history (e.g. an illegible product marking).
- It becomes obsolete due to changes (for example, in legislation, standards, technique, or incompatibility with other equipment).
Destroy these products to prevent further use.

Icons:

A. Lifespan - B. Marking - C. Acceptable temperatures - D. Usage precautions - E. Cleaning/disinfection - F. Drying - G. Storage/transport - H. Maintenance - I. Modifications/repairs (prohibited outside of Petzl facilities, except replacement parts) - J. Questions/contact

3-year guarantee

Against any material or manufacturing defect. Exclusions: normal wear and tear, oxidation, modifications or alterations, incorrect storage, poor maintenance, negligence, uses for which this product is not designed.

Warning symbols

1. Situation presenting an imminent risk of serious injury or death. 2. Exposure to a potential risk of accident or injury. 3. Important information on the functioning or performance of your product. 4. Equipment incompatibility.

Traceability and markings

a. Body controlling the manufacture of this PPE - b. Notified body performing the EU type examination - c. Traceability: datamatrix - d. ANSI/CSA certification body - e. Serial number - f. Year of manufacture - g. Month of manufacture - h. Batch number - i. Individual identifier - j. Standards - k. Read the Instructions for Use carefully - l. Model identification - m. Installation direction - n. Single-person use - o. Manufacturer address - p. Date of manufacture (month/year) - q. Materials - r. Compatibility - s. Do not use for fall arrest - t. Nominal maximum load - u. Maximum length of lanyard

